



FLAWTECH

The World Leader in Manufacturing Real Flaws

Specimen Catalogue

www.FlawTech.com

TABLE of CONTENTS

- 1 FLAWED SPECIMEN CATEGORIES
- 2 FLAWTECH DISCONTINUITIES LIST
- 3 FLAW CROSS SECTION VIEWS
- 4 FLAW CROSS SECTION VIEWS
- 5 FLAW CROSS SECTION VIEWS & CORROSION VISUAL
- 6 STANDARD KITS
- 7 STANDARD RADIOGRAPHIC KIT
- 8 STANDARD ULTRASONIC KIT
- 9 STANDARD MAGNETIC PARTICLE & LIQUID PENETRANT KIT
- 10 STANDARD VISUAL KIT
- 11 NDT DEMONSTRATION KIT
- 12 PRACTICAL EXAM SPECIMENS
- 13 ULTRASONIC PRACTICAL EXAM SPECIMENS
- 14 MT/PT & VT PRACTICAL EXAM SPECIMENS
- 15 ADVANCED SPECIMENS
- 16 ADVANCED SPECIMENS
- 17 ADVANCED SPECIMENS
- 18 API-UT-1 FLAWED SPECIMEN KIT
- 19 API-UT-1 MINI KIT
- 20 API RP-2X SPECIMEN KIT & API RP-2X PRACTICE TEST KIT
- 21 AWS / CWI VISUAL SPECIMEN KIT
- 22 TRAVELER CWI VISUAL TRAINING KIT
- 23 AWS / CWI PLUS PT ENDORSEMENT KIT
- 24 AWS STRUCTURAL WELD SEISMIC KIT
- 25 SOCKET WELD SPECIMEN KIT
- 26 BOILER TUBE DAMAGE KIT
- 27 ASME SECTION XI, APPENDIX VII KIT
- 28 ASME SECTION XI, APPENDIX VII KITS
- 29 UT CALIBRATION BLOCKS
- 30 PDI UT CALIBRATION BLOCKS
- 31 ASME UT CALIBRATION STANDARDS
- 32 PDI UT 10 CALIBRATION STANDARDS

FLAWED SPECIMEN CATEGORIES

STANDARD SPECIMEN

- Have a tolerance of +/- 0.150" (4mm).
- Includes all standard kit specimens and all UT & MT / PT practical exam specimens.
- Designed to enhance the training and development of new and veteran NDT technicians.
- Normally smaller in size and less expensive than Advanced and Critical specimens.
- Basic Document Package with CAD drawings is included with each kit or exam specimen.
- Custom specimens are available at this level of tolerance.

ADVANCED SPECIMEN

- Have a tolerance of +/- 0.080" (2mm).
- Includes all advanced specimens, API-UT-1 kit & all ASME section XI appendix VII specimen bank.
- Designed to enhance the training & qualification of level I, II, & III personnel with regards to SNT-TC-1 A, EN473 & PCN.
- Stock Advanced Specimens are larger in size than the standard specimen and higher tolerance.
- Document package with CAD drawings is included with each kit or individual Advanced Specimen.
- Custom specimens are available at this level of tolerance.

CRITICAL SPECIMEN

- Have a tolerance of +/- 0.040" (1mm).
- Includes all ASME Section XI Appendix VIII specimens & most of the custom designed specimens.
- Designed to customer specifications for their training & qualification of NDT personnel, equipment, and procedures.
- Size of specimens range from a small bolt for the space shuttle to a 20,000 pound reactor nozzle.
- Detailed documentation is included with specimens. Contact FlawTech for exact details.
- Custom specimens are available at this level of tolerance.

FLAWTECH DISCONTINUITIES LIST

#	FLAW TYPE	WELD	NDT METHOD				
10	TOE CRACK	SV/DV	-	MT/PT	UT	RT	
11	TOE CRACK	FILLET	-	MT/PT	UT	-	

12	ROOT CRACK	SV	-	MT/PT	UT	RT
13	UNDERBEAD CRACK	FILLET	-	-	UT	-
14	CENTERLINE CRACK (SURFACE)	SV/DV	-	MT/PT	UT	RT
15	CENTERLINE CRACK (SUB SURFACE)	SV/DV	-	-	UT	RT
16	CIRCUMFERENTIAL CRACK (FLUSH CROWN)	SV/DV	-	MT/PT	UT	RT
17	TRANSVERSE CRACK (FLUSH CROWN)	SV/DV	-	MT/PT	UT	-
18	BASE METAL CRACK (CROWN HAZ AREA)	SV/DV	-	MT/PT	UT	-
19	BASE METAL CRACK (ROOT HAZ AREA)	SV	-	MT/PT	UT	-
20	CRATER CRACK (CROWN STOP/START AREA)	SV/DV	VT	MT/PT	-	-
30	POROSITY (SUB-SURFACE)	SV/DV	-	-	UT	RT
31	POROSITY (SUB-SURFACE)	FILLET	VT	-	UT	RT
32	POROSITY (SURFACE)	SV /DV	-	MT/PT	-	-
33	POROSITY (SURFACE)	FILLET	-	MT/PT	-	-
34	SINGLE GAS PORE	SV/DV	-	-	UT	RT
35	SINGLE GAS PORE	FILLET	-	-	-	RT
36	SLAG INCLUSION (ROOT AREA)	SV	-	-	UT	RT
37	SLAG INCLUSION (WELD GROOVE AREA)	SV/DV	-	-	UT	RT
38	SLAG INCLUSION (ROOT AREA)	FILLET	-	-	UT	RT
39	TUNGSTEN INCLUSION (ROOT AREA)	SV/DV	-	-	-	RT
50	LAMINATION (BASE METAL)	SV	-	-	UT	-
51	LAMINATION (BASE METAL)	WP FACE	-	MT/PT	-	-
52	LACK OF FUSION (SUB-SURFACE)	SV/DV	-	-	UT	-
53	LACK OF FUSION (SURFACE BREAKING)	SV/DV	-	MT/PT	UT	-
54	LACK OF FUSION (SURFACE BREAKING)	FILLET	-	MT/PT	-	-
55	LACK OF FUSION (ROOT AREA)	SV	-	MT/PT	UT	-
56	INCOMPLETE ROOT PENETRATION	SV	VT	MT/PT	UT	RT
57	INCOMPLETE ROOT PENETRATION	DV	-	-	UT	RT
58	INCOMPLETE ROOT PENETRATION (BRIDGING)	FILLET	-	-	UT	-
59	INCOMPLETE GROOVE WELD (CROWN AREA)	SV/DV	VT	MT/PT	UT	RT
70	ROOT CONCAVITY	SV	VT	-	-	RT
71	EXCESS ROOT PENETRATION	SV	VT	-	-	RT
72	MISALIGNMENT (ROOT & CROWN AREA)	SV	VT	-	-	RT
73	UNEVEN LEG LENGTH	FILLET	VT	-	-	-
74	EXCESS CROWN	SV/DV	VT	-	-	-
75	EXCESS CROWN	FILLET	VT	-	-	-
76	CONCAVE CROWN	SV/DV	VT	-	-	-
77	CONCAVE CROWN	FILLET	VT	-	-	-
78	UNDERCUT	SV/DV	VT	-	-	-
79	UNDERCUT	FILLET	VT	-	-	-
80	OVERLAP	FILLET	VT	MT/PT	-	-
90	WELD SPLATTER	SV/DV	VT	-	VT	RT
91	WELD SPLATTER	FILLET	VT	-	VT	RT
92	CHIPPING HAMMER MARKS	SV/DV	VT	-	VT	RT
93	CHIPPING HAMMER MARKS	FILLET	VT	-	VT	-
100	CORROSION	SV/DV	VT	-	VT	RT
101	ERROSION	FILLET	VT	-	VT	RT

FLAWED CROSS SECTION VIEWS



10
Toe Crack in Single Vee
MT/PT, UT

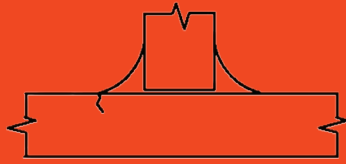

11
Toe Crack in Fillet
MT/PT, UT



12
Root Crack in Single Vee
MT/PT, UT, RT

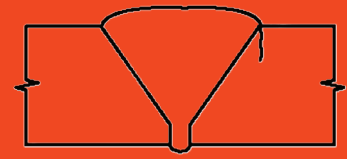

14
Centerline Crack, Single Vee
(surface breaking) MT/PT, UT, RT



15
Centerline Crack, Single Vee
(sub-surface) UT, RT



15
Centerline Crack in Single Vee
(sub-surface) UT, RT



16
Circumferential Crack in Single
Vee, flush crown MT/PT, UT



17
Transverse Crack in Single
Vee, flush crown MT/PT, UT



18 Base Metal Crack in Single
Vee (top HAZ area)
MT/PT, UT



19 Base Metal Crack in
Single Vee (bottom HAZ area)
MT/PT, UT



20
Crater Crack (crown
stop-start area) MT/PT, UT

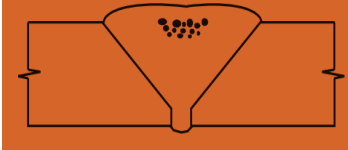

30
Porosity in Single Vee
(sub-surface) UT, RT



30
Porosity in Double Vee
(sub-surface) UT, RT

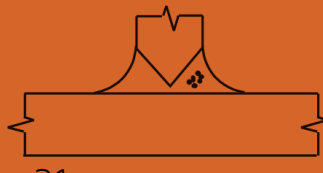

31
Porosity in Fillet
(sub-surface) UT, RT

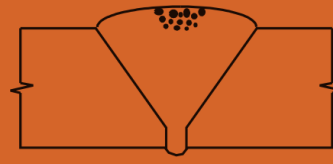

32
Porosity in Single Vee (surface
breaking) VT, MT/PT

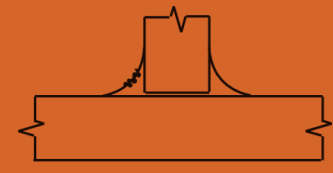

33
Porosity in Fillet
(surface breaking) VT, MT/PT

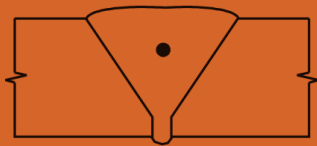

34
Single Gas Pore in Single
Vee UT, RT



36
Slag Inclusion in Single
Vee (root area) UT, RT



37
Slag Inclusion in Single Vee
(weld groove area) UT, RT



38
Slag Inclusion in Fillet
(root area) UT, RT

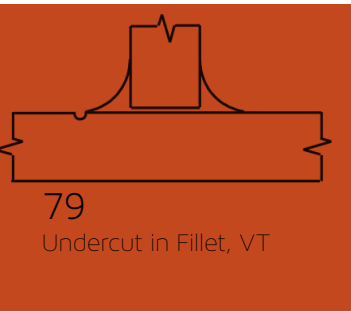
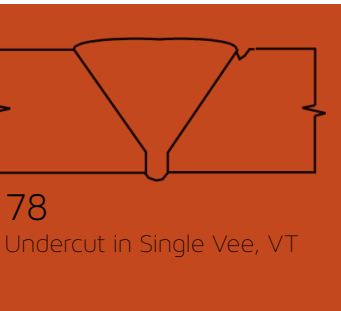
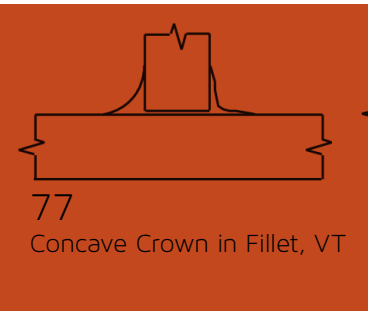
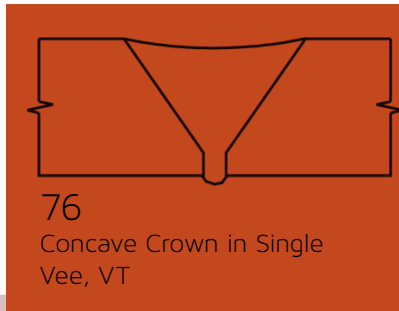
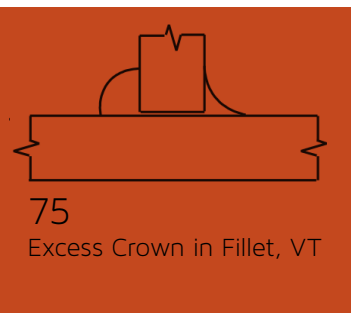
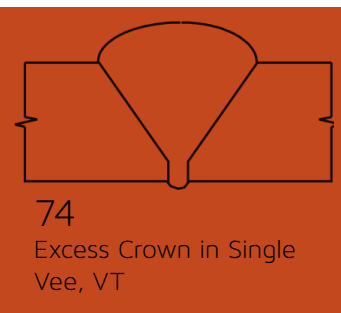
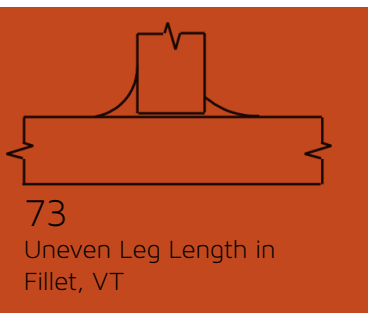
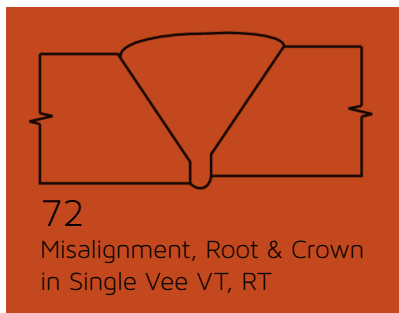
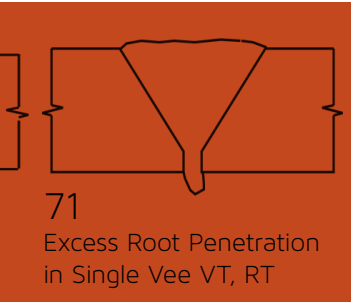
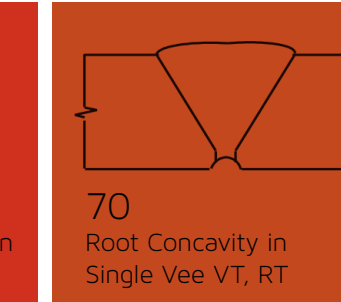
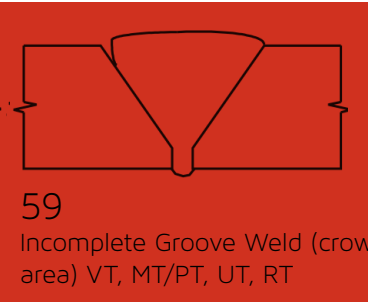
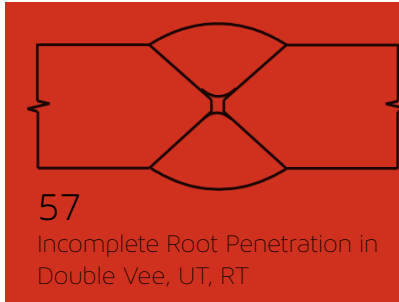
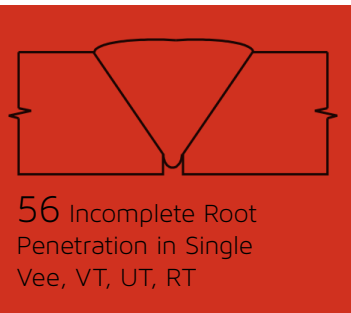
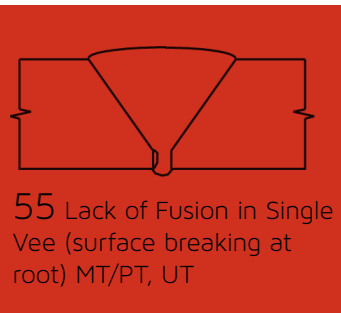
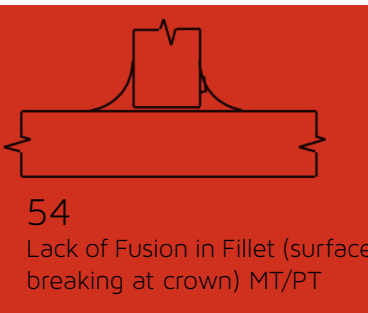
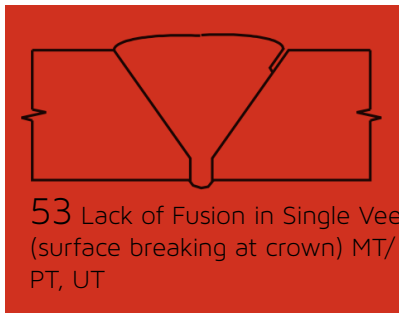
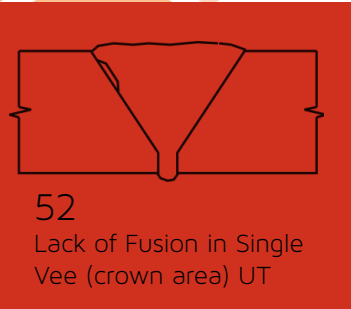
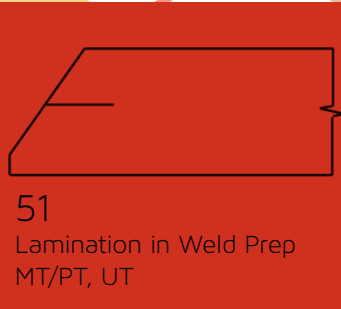
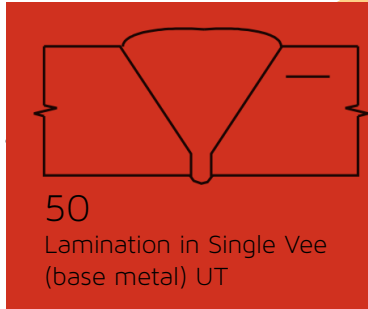
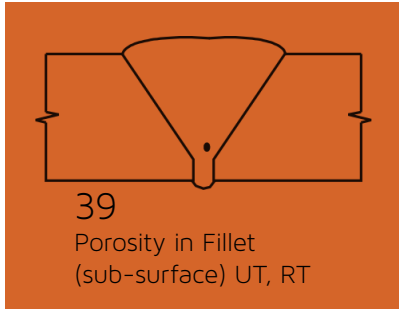

Continued on Page 5

FLAWED CROSS SECTION VIEWS

Continued from Page 4

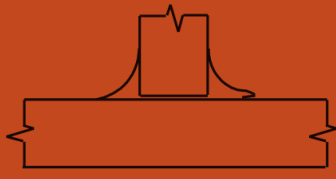

80
Overlap in Fillet VT, MT/PT

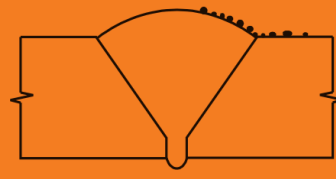

90
Weld Splatter on Single Vee,
VT, RT

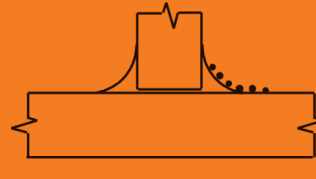

91
Weld Splatter on Filler VT, RT

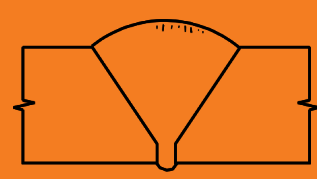

92
Chipping Hammer Marks
on Single Vee, VT, RT



100
Corrosion



101
Erosion

CORROSION

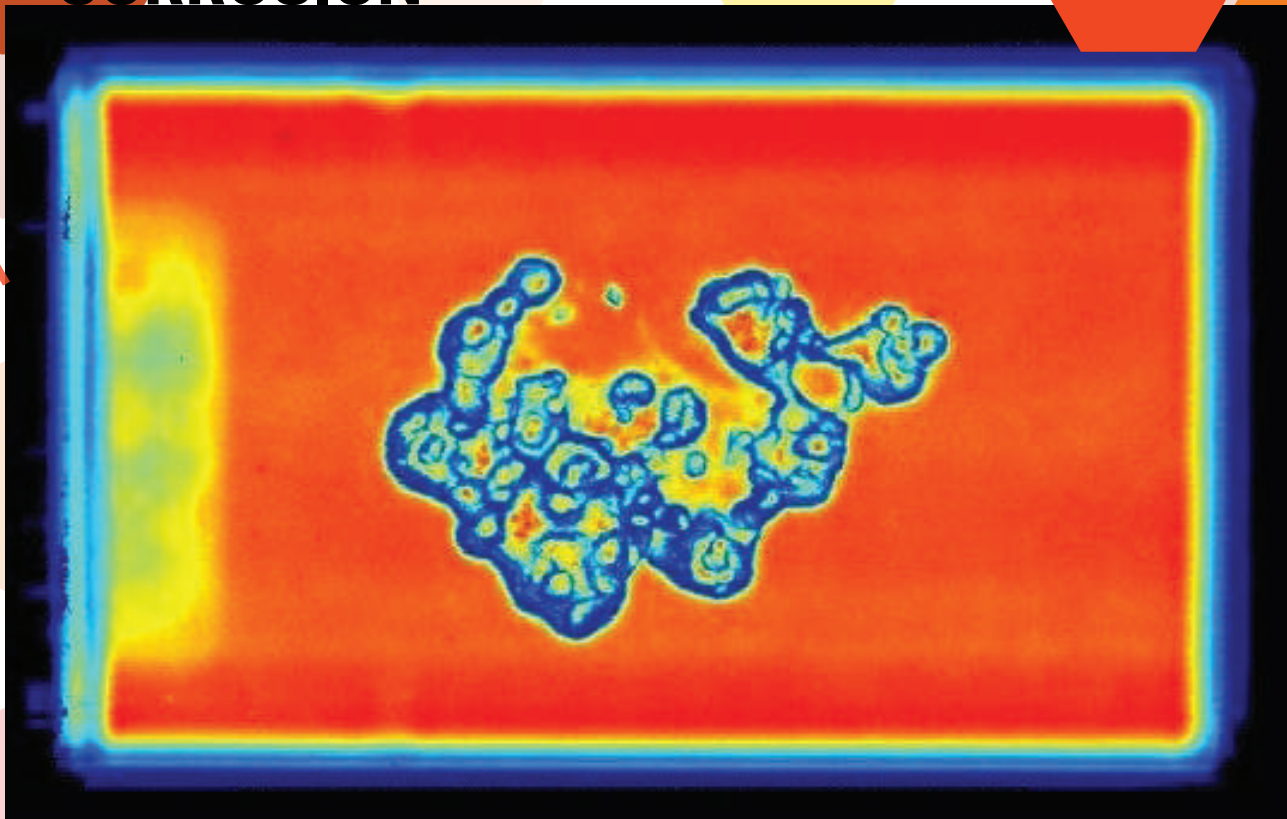

This is a view of a surface corrosion indication manufactured by FlawTech. The geometry and depth of the indication can be controlled and can be manufactured in most any alloy. This image was provided to FlawTech by MISTRAS Products and Programs Division using their ULTRAPAC™ Immersion System with Ultra Win™ data program.

STANDARD KITS

FlawTech Standard Kit Specimens are designed to enhance the training and development of new and veteran technicians. Kits will assist with basic flaw detection and sizing of real flaws found in common weld geometries. Each kit is shown in further detail on the following pages.

RT Kit
#RK-1

UT Kit
#UK-1

MT/PT Kit
#MK-1

VT Kit
#VK-1

EACH KIT CONTAINS:

- 10 Carbon Steel Specimens per kit / custom alloys available
- 20 "Real" flaws per kit / 2 per specimen randomly placed
- "Free" Carrying Case
- Detailed Document Package with CAD drawings

Demonstration Kit #DK-1 (Great Introduction to NDT kit)

- 5 Carbon Steel Specimens
- 2 RT, 1 UT, 1 VT & 1 MT/PT Specimens
- Total Of 11 Real Flaws
- Includes Documentation and Case

Reference Radiographs

#RR-1

- Total of 16 Radiographs
- Showing 20 Real Flaws
- Plus 6 Processing Defects
- Includes Documentation and Film



See the following pages for Kit details.

#RK-1

STANDARD RADIOGRAPHIC KIT

THE RADIOGRAPHIC KIT CONTAINS:
8 Plates, 1 Pipe & 1 Tee / Carbon Steel

Each specimen contains 2 "REAL FLAWS,"
randomly placed

Actual X-Ray film is provided for each specimen.
Specimens are packaged in 2 FREE CARRYING
CASES. Complete with Document Package with
"Flaw Truth" documented by CAD drawings with a
Standard Tolerance of (+ / -) 0.150" (4mm).

The Standard Radiographic Examination Kit
contains 20 flaws similar to those shown in the
cross section drawings below.

Visit www.flawtech.com or call for price
information.



Kit Includes:

- 12 - Root Crack in SV
- 14 - Centerline Crack SV (Surface breaking)
- 15 - Centerline Crack, SV (Sub-surface)
- 30 - Porosity SV / DV
- 31 - Porosity Fillet (sub surface)
- 34 - Single Gas Pore SV
- 36 - Slag Inclusion SV (root area)
- 37 - Slag Inclusion SV (weld groove area)
- 38 - Slag Inclusion Fillet (root area)
- 39 - Tungsten Inclusion SV (root area)
- 56 - Incomplete Root Penetration SV
- 57 - Incomplete Root Penetration DV
- 59 - Incomplete Groove Weld (crown area)
- 70 - Root Concavity SV
- 71 - Excess Root Penetration SV
- 72 - Misalignment Root & Crown SV
- 90 - Weld Splatter SV
- 92 - Chipping Hammer Marks SV

See Pages 3-5 for Cross Section Views

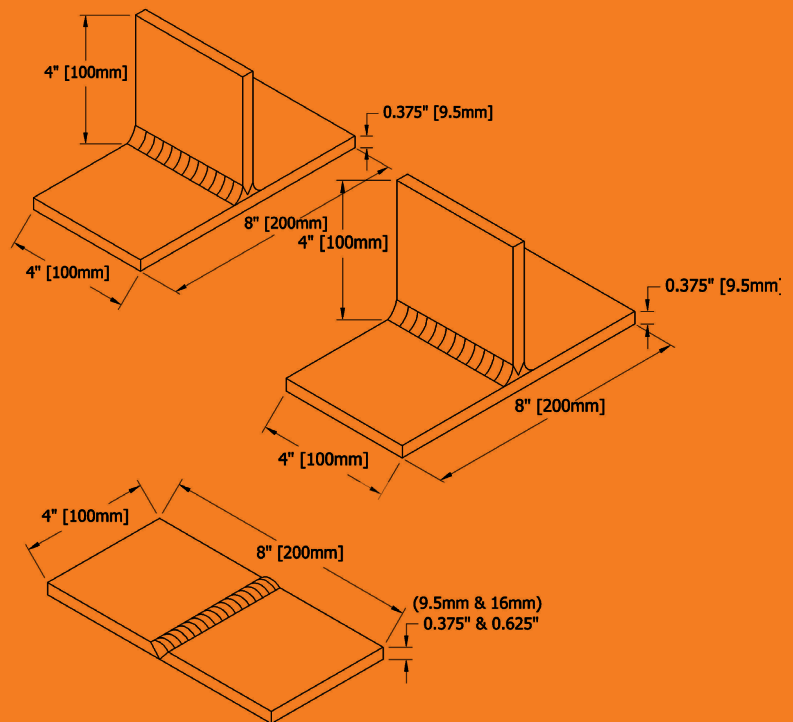

Shipping Weight 65 lbs

All Specimens Contain Real Flaws

#UK-1

STANDARD ULTRASONIC KIT

THE ULTRASONIC KIT CONTAINS:
8 Plates, 1 Pipe & 1 Tee / Carbon Steel

Each specimen contains 2 "REAL FLAWS,"
randomly placed

Specimens are packaged in 2 FREE
CARRYING CASES. Complete with
Document Package with "Flaw Truth"
documented by CAD drawings with a
Standard Tolerance of (+ / -) 0.150" (4mm).

The Standard Ultrasonic Examination Kit
contains 20 flaws similar to those shown in
the cross section drawings below.

Visit FlawTech Website or call for price
information.



Kit Includes:

- 10 - Toe Crack SV
- 12 - Root Crack in SV
- 15 - Centerline Crack, SV (Sub-surface)
- 16 - Circumferential Crack SV (flush crown)
- 17 - Transverse Crack in SV (flush crown)
- 18 - Base Metal Crack SV (top HAZ area)
- 30 - Porosity DV (sub-surface)
- 31 - Porosity Fillet (sub-surface)
- 34 - Single Gas Pore SV
- 37 - Slag Inclusion SV (weld groove area)
- 38 - Slag Inclusion Fillet (root area)
- 50 - Lamination SV (base metal)
- 52 - Lack of Fusion SV (crown area)
- 55 - Lack of Fusion SV (surface breaking at root)
- 56 - Incomplete Root Penetration SV
- 57 - Incomplete Root Penetration DV
- 59 - Incomplete Groove Weld (crown area)

See Pages 3-5 for Cross Section Views

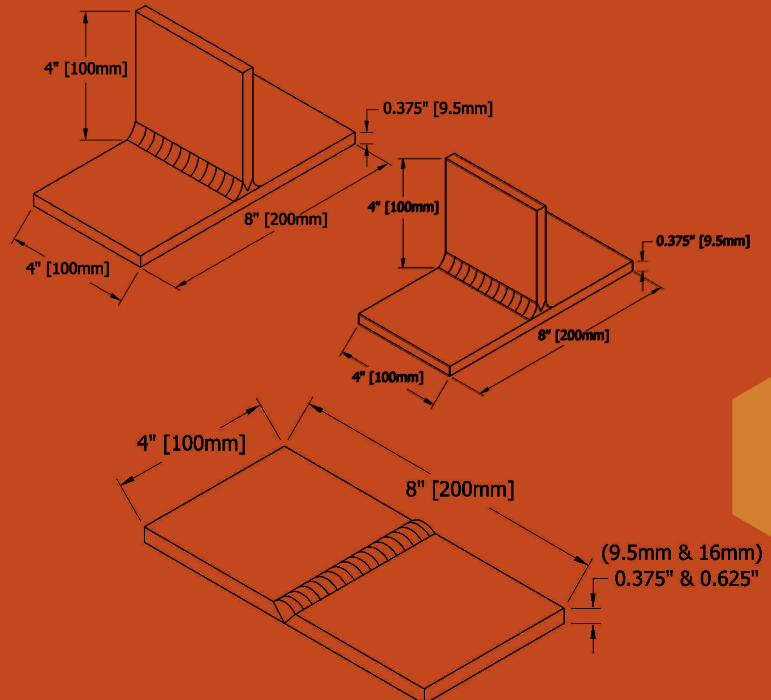

Shipping Weight 65 lbs

All Specimens Contain Real Flaws

#MK-1

STANDARD MAGNETIC PARTICLE/ LIQUID PENETRANT KIT

THE MT/PT KIT CONTAINS:
8 plates & 2 Tees / Carbon Steel

Each specimen contains 2 "REAL FLAWS,"
randomly placed

Specimens are packaged in a FREE CARRYING
CASE. Complete with Document Package with
"Flaw Truth" documented by CAD drawings
with a Standard Tolerance of (+ / -) 0.150"
(4mm).

The Standard MT/PT Kit contains 20 "real"
flaws similar to those shown in the cross
section drawings below.

Optional PT Kit with stainless specimens
#SSPK-1

Optional stainless steel penetrant kit (#SSPK-
1); same design as #MK-1 kit.



Kit Includes:

- 10 - Toe Crack SV
- 11 - Toe Crack Fillet
- 12 - Root Crack in SV
- 14 - Centerline Crack SV (surface breaking)
- 16 - Circumferential Crack SV (flush crown)
- 17 - Transverse Crack in SV (flush crown)
- 18 - Base Metal Crack SV (top HAZ area)
- 19 - Base Metal Crack SV (bottom HAZ area)
- 20 - Crater Crack SV (surface stop-start area)
- 32 - Porosity SV (surface breaking)
- 33 - Porosity fillet (surface breaking)
- 51 - Lamination Weld Prep
- 53 - Lack of Fusion SV (surface breaking at crown)
- 54 - Lack of Fusion SV (surface breaking at root)
- 55 - Lack of Fusion SV (surface breaking at root)
- 80 - Overlap Fillet

See Pages 3-5 for Cross Section Views
Visit www.FlawTech.com or call for price information.

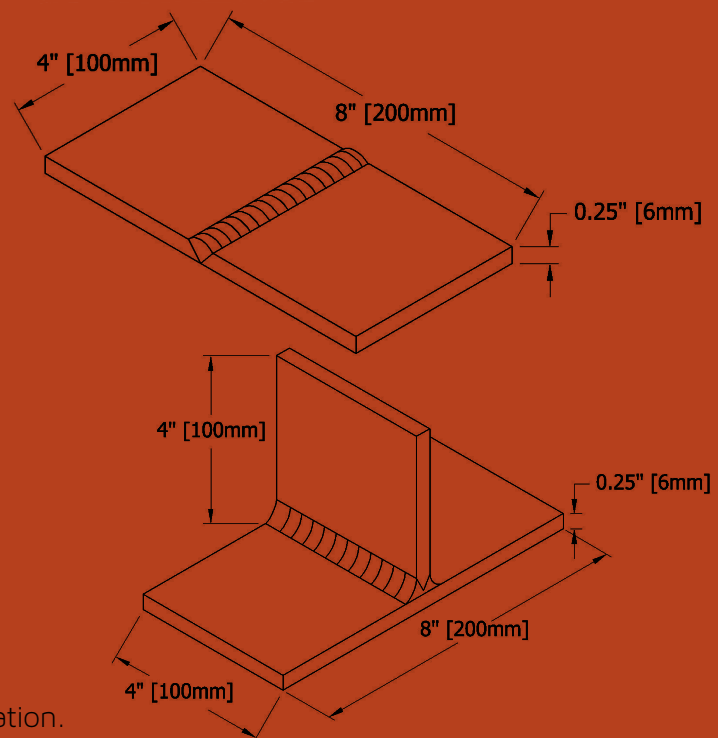

Shipping Weight 35 lbs

All Specimens Contain Real Flaws

#VK-1

STANDARD VISUAL KIT

THE VISUAL KIT CONTAINS:
7 Plates & 3 Tees / Carbon Steel

Each specimen contains 2 "REAL FLAWS," randomly placed.

Specimens are packaged in a FREE CARRYING CASE. Complete with Document Package with "Flaw Truth" documented by CAD drawings with a Standard Tolerance of (+ / -) 0.150" (4mm).

The Standard Visual Examination Kit contains 20 flaws similar to those shown in the cross section drawings below.

Visit www.FlawTech.com or call for price information.



Kit Includes:

- 20 - Crater Crack SV (surface stop-start area)
- 32 - Porosity SV (surface breaking)
- 33 - Porosity fillet (surface breaking)
- 56 - Incomplete Root Penetration SV
- 59 - Incomplete Groove Weld (crown area)
- 70 - Root Concavity SV
- 71 - Excess Root Penetration SV
- 72 - Misalignment Root & Crown SV
- 73 - Uneven Leg Length Fillet
- 74 - Excess Crown SV
- 75 - Excess Crown Fillet
- 76 - Concave Crown SV
- 77 - Concave Crown Fillet
- 78 - Undercut SV
- 79 - Undercut Fillet
- 80 - Overlap Fillet
- 90 - Weld Splatter SV
- 91 - Weld Splatter on Filler

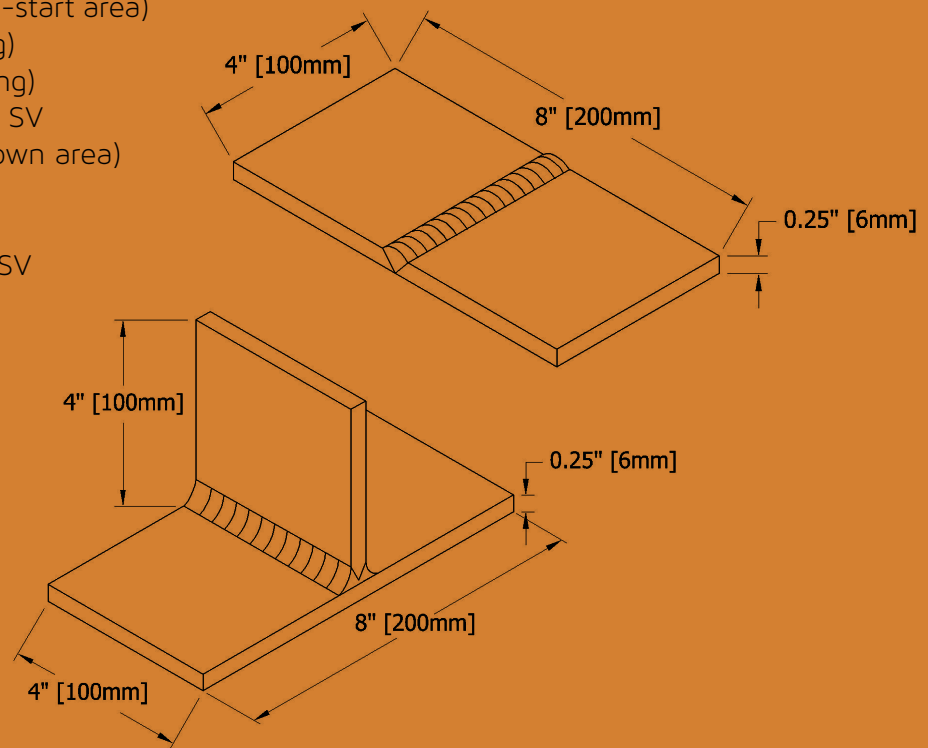

Shipping Weight 35 lbs

All Specimens Contain Real Flaws

#DK-1

NDT DEMONSTRATION KIT

THE NDT DEMONSTRATION KIT CONTAINS:

3 Plates, 1 Pipe & 1 Tee
 11 Discontinuities, "REAL FLAWS," randomly placed

Specimens are packaged in a FREE CARRYING CASE. The "Flaw Truth" is documented on CAD drawings with a Standard Tolerance of (+ / -) 0.150" (4mm).

This Kit contains actual X-Ray film for RT specimens and a "Flaw Locator" for UT specimens.

This standard NDT Demonstration Kit contains 11 flaws in 5 specimens. The flaws in these specimens can be examined by several different NDT methods to demonstrate the advantages and disadvantages of each NDT method. See Kit Price List for cost and listings of other flaw types available only from FlawTech.

Visit www.FlawTech.com or call for price information.



- 11 - Toe Crack fillet
- 15 - Center Line Crack DV (sub-surface)
- 18 - Base Metal Crack SV
- 19 - Base Metal Crack in root HAZ
- 20 - Crater Crack (crown stop-start area)
- 30 - Porosity SV (sub-surface)
- 32 - Porosity SV (surface)
- 37 - Slag Inclusion SV
- 54 - Lack of Fusion Fillet (surface breaking)
- 57 - Incomplete Root Penetration DV
- 71 - Excess Root SV

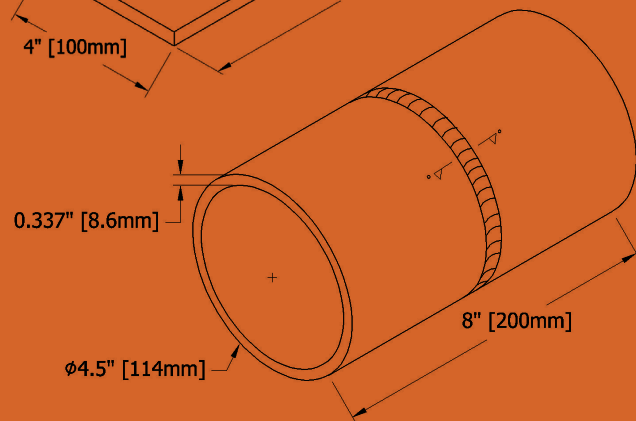
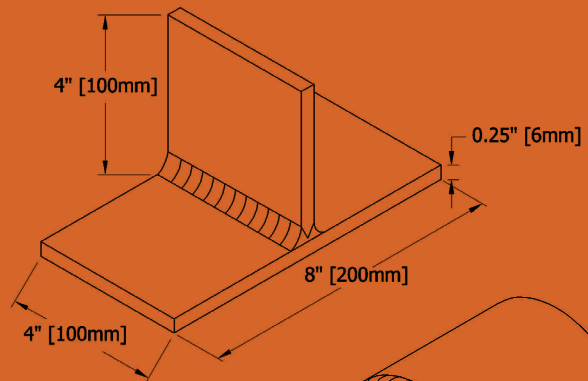
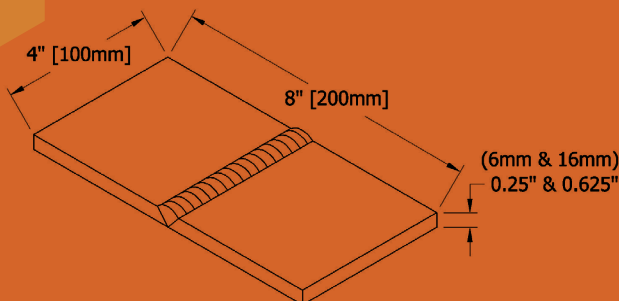

Shipping Weight 35 lbs

PRACTICAL EXAM SPECIMENS

For UT, MT/PT, and VT

DESIGN SPECIFICATIONS

- Practical exam specimens are larger than our "standard" kit specimens
- 12 UT and 12 MT / PT specimens to choose from
- Each specimen will contain 3 randomly placed "real" flaws
- Designed to enhance the training and qualification of level I & II personnel with regards to ISO9712, PCN & TC - 1A
- Customize your set to meet your requirements
- Purchase any combination of specimens to make your set
- Purchase 3+ specimens and receive a 10% discount & a "free" carrying case
- If you do not see what you need - custom specimens are available

See the following pages for Kit details.



ULTRASONIC PRACTICAL EXAM SPECIMENS

PLATES & SHEETS
0.75" x 8" x 10" plate
#P101



BAR & ROD STOCK
1.5" OD x 12"
#P102



BAR & ROD STOCK
4" OD x 6"
#P103



L/R 90° ELBOW TO PIPE
2" SCH160 (.344" T)
#P104



NODE TO PLATE WELD
2" SCH160 to .375" PLATE
#P105

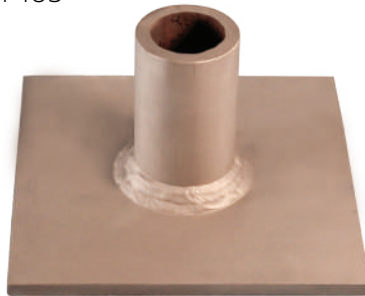

PIPE TO SOCKET WELD
2" SCH160 PIPE to COUPLING
#P106



WELDED PLATE
0.5"x8"x12"
#P107

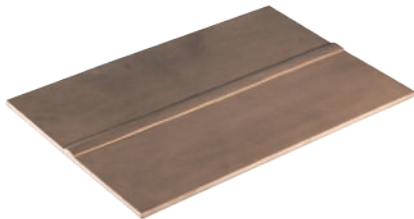

WELDED PLATE
1.0"x6"x10"
#P108

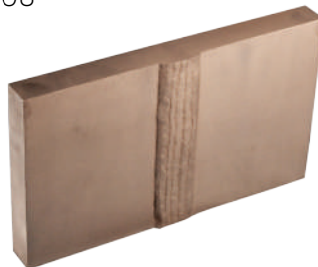

WELDED PIPING
4" SCH160(0.53"T)x 8"
#P109



LAP JOINT
0.5" x 12" x 6"
#P110

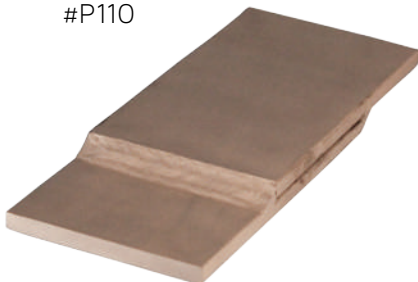

FORGED PIPE FLANGE 6" OD x
0.75" thick
#P111

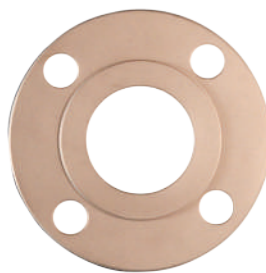

WELDED TEE
0.5" x 8" x 8" x 4"
#P112



PRACTICAL EXAM SPECIMEN DETAILS: Standard tolerance (+/-) 0.150" (4mm)

Blank specimens available

Custom specimens available

Applicable for ISO9712, PCN & TC - 1A

MT / PT & VT PRACTICAL EXAM SPECIMENS

CAST FITTING
2.0" to 1.3" reducer, 5" long
MT/PT #P001
VT #P201



MACHINED SPINDLE
1.75" diameter x 8"
MT/PT #P002
VT #P202



BOLT & NUT
1.25" OD x 6"
MT/PT #P003
VT #P203

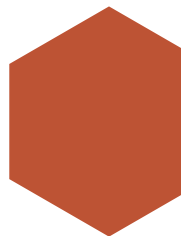

FORGED EYE HOOK
6" long with 2" eye
MT/PT #P004
VT #P204



FORGED SHACKLE & PIN
4.25" with 0.75" pin
MT/PT #P005
VT #P205



FORMED METAL PLATE
0.25" x 4"
MT/PT #P006
VT #P206



WELDED PLATE
0.25"x8"x12"
MT/PT #P007
VT #P207

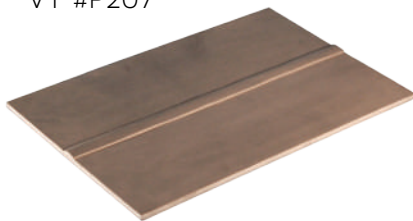

WELDED PIPING
4" SCH40 (0.25" T) x 8"
MT/PT #P008
VT #P208

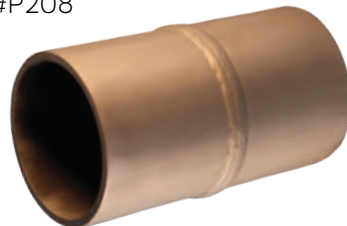

FORGED PIPE FLANGE
6" OD x 0.75" thick
MT/PT #P009
VT #P209

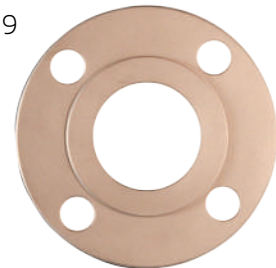

MACHINED GEAR
4.6" diameter x 1.5" bore
MT/PT #P010
VT #P210



WELDED TEE
0.25" x 8" x 8" x 4"
MT/PT #P011
VT #P211

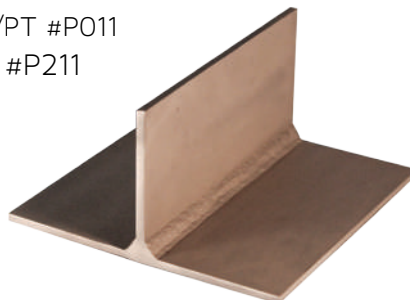

PIPE to SOCKET WELD 2"
SCH160 PIPE to COUPLING
MT/PT #P012
VT #P212



"REAL FLAWS" in each specimen
Discount & free carrying case with Purchase of 3+ specimens

Document Package with each specimen
Specimens are carbon steel

3 Flaws per specimen
Specimens are carbon steel

ADVANCED SPECIMENS

PART NUMBER	SPECIMEN TYPE	DIMENSIONS (INCHES)
UA-101	Plate w/ SV	0.25" X 12" X 12"
UA-102	Plate w/ SV	0.375" X 12" X 12"
UA-103	Plate w/ SV	0.5" X 12" X 12"
UA-104	Plate w/ SV	0.625" X 12" X 12"
UA-105	Plate w/ SV	0.75" X 12" X 12"
UA-106	Plate w/ SV	1.0" X 12" X 12"
UA-108	Plate w/ SV	1.5" X 12" X 18"
UA-153	Plate w/ DV	0.5" X 12" X 12"
UA-155	Plate w/ DV	0.75" X 12" X 12"
UA-156	Plate w/ DV	1.0" X 12" X 16"
UA-157	Plate w/ DV	1.25" X 12" X 17"
UA-158	Plate w/ DV	1.5" X 12" X 18"
UA-1511	Plate w/ DV	3" X 12" X 18"
UA-20.753	Pipe w/ SV	0.75" SCHSTD (0.113") X 12"
UA-20.754	Pipe w/ SV	0.75" SCHXS (0.154") X 12"
UA-20.755	Pipe w/ SV	0.75" SCH160 (0.219") X 12"
UA-214	Pipe w/ SV	1" SCHXS (0.179") X 12"
UA-215	Pipe w/ SV	1" SCH160 (0.25") X 12"
UA-216	Pipe w/ SV	1" SCHXX (0.382") X 12"
UA-223	Pipe w/ SV	2" SCHSTD (0.154") X 12"
UA-224	Pipe w/ SV	2" SCH80 (0.218") X 12"
UA-226	Pipe w/ SV	2" SCHXX (0.436") X 12"
UA-22.54	Pipe w/ SV	2.5" SCH80 (0.276") X 12"
UA-22.56	Pipe w/ SV	2.5" SCHXX (0.552") X 12"
UA-233	Pipe w/ SV	3" SCH40 (0.216") X 12"
UA-234	Pipe w/ SV	3" SCH80 (0.3") X 12"
UA-235	Pipe w/ SV	3" SCH160 (0.438") X 12"
UA-236	Pipe w/ SV	3" SCHXX (0.6") X 12"
UA-246	Pipe w/ SV	4" SCH80 (0.337") X 12"
UA-248	Pipe w/ SV	4" SCH160 (0.513") X 12"
UA-249	Pipe w/ SV	4" SCHXX (0.674") X 12"
UA-263	Pipe w/ SV	6" SCH40 (0.28") X 12"
UA-264	Pipe w/ SV	6" SCHXS (0.432") X 12"
UA-265	Pipe w/ SV	6" SCH120 (0.562") X 12"
UA-267	Pipe w/ SV	6" SCH160 (0.719") X 12"
UA-268	Pipe w/ SV	6" SCHXXH (0.864") X 12"
UA-285	Pipe w/ SV	8" SCH40 (0.322") X 12"
UA-287	Pipe w/ SV	8" SCH80 (0.5") X 12"
UA-288	Pipe w/ SV	8" SCH100 (0.594") X 12"
UA-2810	Pipe w/ SV	8" SCH140 (0.812") X 12"
UA-2812	Pipe w/ SV	8" SCHSTD (0.906") X 12"
UA-2815	Pipe w/ SV	8" w/ 1.5" wall X 12"
UA-2127	Pipe w/ SV	12" SCHXS (0.5") X 12"
UA-21211	Pipe w/ SV	12" SCH120 (1.0") X 12"
UA-2143	Pipe w/ SV	14" SCH20 (0.312") X 12"
UA-2145	Pipe w/ SV	14" SCH40 (0.438") X 12"
UA-2148	Pipe w/ SV	14" SCH80 (0.75") X 12"
UA-21411	Pipe w/ SV	14" SCH140 (1.25") X 18"

UT (DESIGNED FOR SHEAR WAVE)

UA-21611	Pipe w/ SV	16" SCH160 (1.594") X 20"
UA-303	Tee w/ SV	0.5" X 8" X 8" X 12"
UA-305	Tee w/ SV	0.75" X 8" X 8" X 12"
UA-306	Tee w/ SV	1.0" X 8" X 8" X 12"
UA-356	Tee w/ DV	1.0" X 8" X 8" X 12"
UA-357	Tee w/ DV	1.25" X 9" X 9" X 12"
UA-358	Tee w/ DV	1.5" X 10" X 10" X 12"
UA 407	Y-Joint (45°)	1.25" X 9" X 9" X 12"
UA-51010-6	Node & Carrier (Flat)	10" SCH120 (0.844") X 10" & 1.0" X 20" X 20"
UA-687-6	Y-Node (45°) & Carrier (Flat)	8" SCH80 (0.5") X 10" & 1.0" X 20" X 20"
UA-746-3	Nozzle & Carrier (Flat)	4" SCHXS (0.377") X 6" & 0.5" X 12" X 12"
UA-748-3	Nozzle & Carrier (Flat)	4" SCH160 (0.531") X 6" & 0.5" X 12" X 12"
UA-787-6	Nozzle & Carrier (Flat)	8" SCH80 (0.5") X 10" & 1.0" X 20" X 20"
UA-787-20C	Nozzle & Carrier (20" OD X 90° Segment)	8" SCH80 (0.5") X 10" & 20" OD X 0.375" wall X 16" X 90°
UA-7127-3	Nozzle & Carrier (Flat)	12" SCHXS (0.5") X 10" & 0.5" X 24" x 24"
UA-7129-3	Nozzle & Carrier (Flat)	12" SCH80 (0.688") X 10" & 0.5" X 24" x 24"

RT

RA-102	Plate w/SV	0.375" x 12" x 12"
RA-103	Plate w/SV	0.5" x 12" x 12"
RA-105	Plate w/SV	0.75" x 12" x 12"
RA-106	Plate w/SV	1.0" x 12" x 16"
RA-154	Plate w/DV	0.625" x 12" x 12"
RA-156	Plate w/DV	1.0" x 12" x 16"
RA-223	Pipe w/SV	2" SCH40 (0.154") X 12"
RA-224	Pipe w/SV	2" SCH80 (0.218") X 12"
RA-225	Pipe w/SV	2" SCH160 (0.344") X 12"
RA-226	Pipe w/SV	2" SCHXX X (0.436) 12"
RA-242	Pipe w/SV	4" SCH10 (0.12") X 12"
RA-243	Pipe w/SV	4" SCH40 (0.237") X 12"
RA-246	Pipe w/SV	4" SCH80 (0.337") X 12"
RA-248	Pipe w/SV	4" SCH160 (0.531") X 12"
RA-266	Pipe w/SV	6" SCH120 (0.562") X 12"
RA-282	Pipe w/SV	8" SCH10 (0.148") X 12"
RA-285	Pipe w/SV	8" SCH40 (0.322") X 12"
RA-288	Pipe w/SV	8" SCH100 (0.594") X 12"
RA-2810	Pipe w/SV	8" SCH140 (0.812") X 12"
RA-2126	Pipe w/SV	12" SCH40 (0.406") X 12"
RA-2127	Pipe w/SV	12" SCHXS (0.5") X 12"
RA-2129	Pipe w/SV	12" SCH80 (0.688") X 12"

ADVANCED SPECIMENS

PART NUMBER		SPECIMEN TYPE	DIMENSIONS (INCHES)	
ET	ET-101A	Plate (No Weld w/ 4 Flaws)	0.25" x 4" x 12"	
	ET-101B	Plate w/ SV	0.25" x 4" x 12"	
	ET-101C	Plate w/ SV (4 Flaws)	0.25" x 4" x 12"	
	ET-101D	Plate w/ SV (4 EDM Elliptical Notches)	0.25" x 4" x 12"	
MT/PT & VT	PA-102	Plate w/SV (Stainless Steel)	0.375" x 12" x 12"	
	MA-102	VA-102	Plate w/SV	0.375" x 12" x 12"
	MA-223		Pipe w/SV	2" SCH40 (0.154") x 12"
	MA-224	VA-224	Pipe w/SV	2" SCH80 (0.218") x 12"
	MA-234		Pipe w/SV	3" SCH80 (0.3") x 12"
	MA-242	VA-242	Pipe w/SV	4" SCH10 (0.120") x 12"
	MA-246	VA-246	Pipe w/SV	4" SCH80 (0.337") x 12"
	MA-265	VA-265	Pipe w/S-V	6" SCH80 (0.432) x 12"
	MA-282	VA-282	Pipe w/SV	8" SCH10 (0.148") x 12"
	MA-285	VA-285	Pipe w/SV	8" SCH40 (0.322") x 12"
	MA-2126	VA-2126	Pipe w/S-V	12" SCH40 (0.406") x 12"
	MA-2127	VA-2127	Pipe w/SV	12" SCHXS (0.5") x 12"
	MA-302	VA-302	Tee w/SV	0.375" x 6" x 6" x 12"
	MA-303	VA-303	Tee w/ SV	0.5" x 6" x 6" x 12"
	MA-402	VA-402	Y-JOINT (45°)	0.375" x 6" x 6" x 12"
	MA-5106-3	VA-5106-3	NODE & CARRIER (Flat)	10 SCH40 (0.365") x 10 & 0.5" x 16" x 16"
	MA-5107-3	VA-5107-3	NODE & CARRIER (Flat)	10 SCH60 (0.5") x 10 & 0.5" x 16" x 16"
	MA-686-3	VA-686-3	Y-NODE (45°) & CARRIER (Flat)	8" SCH60 (0.4") x 10" & 0.5" x 16" x 16"
	MA-786-3	VA-786-3	NOZZLE & CARRIER (Flat)	8" SCH60 (0.4") x 10" & 0.5" x 16" x 16"
	MA-787-7	VA-786-7	NOZZLE & CARRIER (Flat)	8" SCH60 (0.4") x 10" & 1" x 16" x 16"

ADVANCED SPECIMENS ARE DESIGNED FOR:

- Training and qualification of level I & II personnel with regards to SNT-TC-1A, ISO 9712 & PCN
- Flaw detection, sizing, & interpretation using common weld geometries and flaw types

ADVANCED SPECIMEN DETAILS:

- Larger than our practical exam specimens
- Complete Document Package Included
- 3 Real Flaws per specimen randomly placed
- Material carbon steel (custom alloys available)
- Custom specimens available (contact us for details)

#API-K1 API-UT-1 FLAWED SPECIMEN KIT

For UT Examination of Ferritic Welds

API-UT-1 KIT CONTAINS:

Total Of 4 Specimen

- (1) 1.0" Thick Plate W/ Double Vee (1" X 12" X 15")
- (1) 0.5" Thick Plate W/ Single Vee (0.5" X 10" X 12")
- (1) 8" Sch 80 Pipe (0.5" Wall X 12", 360°)
- (1) 12" Sch 80 Pipe (0.688", Wall X 12", 180° Seg.)

API KIT STANDARD FEATURES

- Complete Document Package W/ CAD Drawings
- Approximately 3 "Real" Flaws Per Specimen
- FlawTech Advanced Tolerance $\pm 0.080"$
- Specimens Are Carbon Steel

API KIT CUSTOM OPTIONS

- 10% ID / OD Calibration Notches
- 0.75" X 4.5 X 6" ASME Sec. V Basic Calibration Block
- 8" Sch 80 (0.5" Wall) X 8" Pipe Asme Sec. V Angle Beam Calibration Block
- Locking Storage Container
- Radiographs

FLAW TYPES

- Lack Of Penetration
- Center Line Crack
- Slag Inclusion
- Lack Of Fusion
- Root Crack
- Porosity
- Misalignment
- Excess
- Penetration

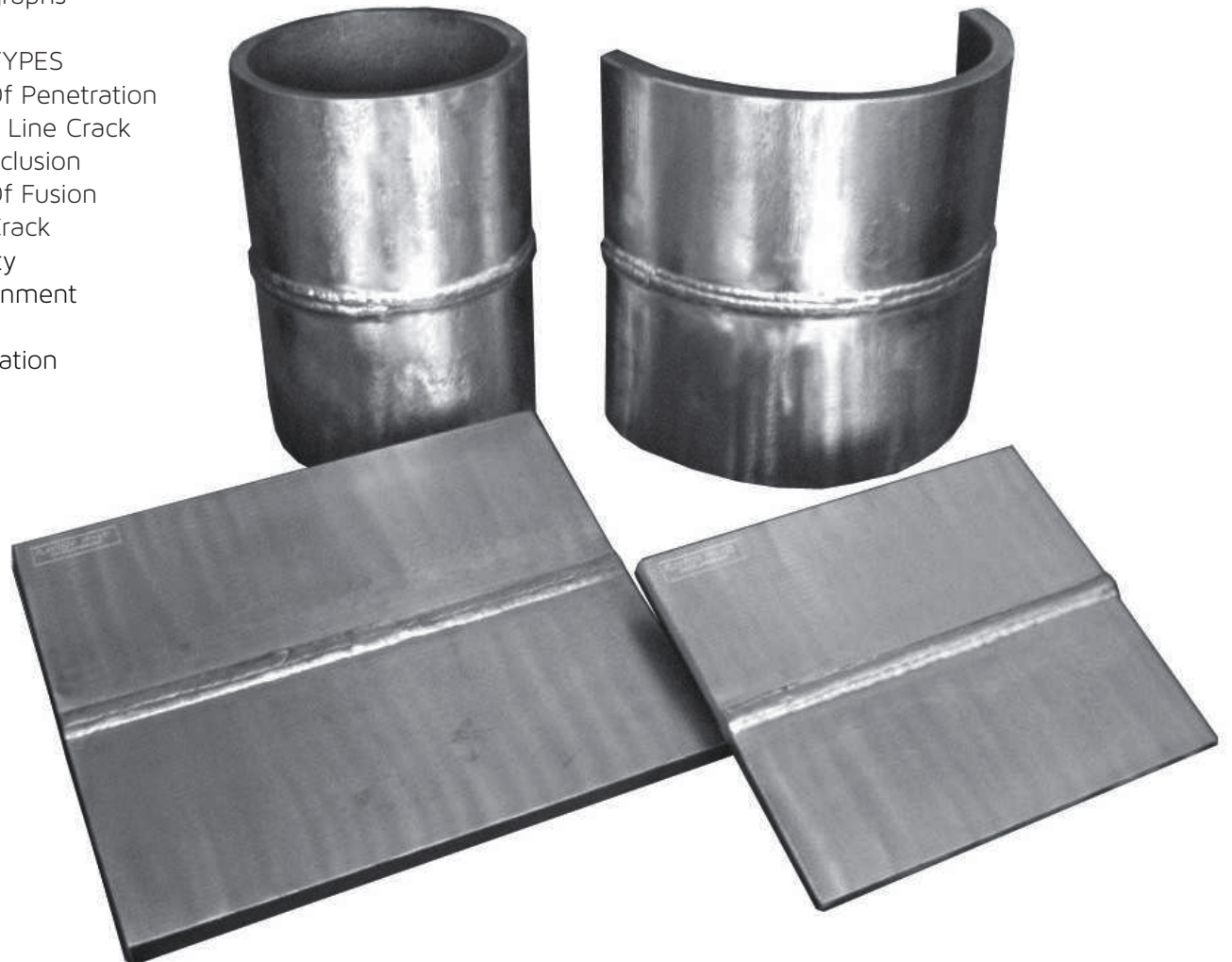

#API-MK

API-UT-MINI KIT

Compact version of our API-UT-1 kit

API-UT-1 MINI KIT CONTAINS:

Total of 4 specimen

- (1) 1.0" Thick Plate w/ Double Vee (1" x 7.5" x 6")
- (1) 0.5" Thick Plate W/ Single Vee (0.5" X 6" X 5")
- (1) 8" Sch 80 Pipe (0.5" Wall X 6", 180°)
- (1) 12" Sch 80 Pipe (0.688", Wall X 6", 90° Seg.)

API MINI KIT STANDARD FEATURES

- Complete document package w/ CAD drawings
- 3 "real" flaws per specimen
- FlawTech advanced tolerance +/- 0.080"
- Specimens are carbon steel
- Designed for ease of handling and transport
- Carrying case 15" x 13" x 10"
- Total weight 50lbs

Note: Specimens may be too small for some UT search units. If this is a concern please consider our standard API-UT-1 Kit.



#RP2X-K1

API RP-2X SPECIMEN KIT

API RP-2X PRACTICE SPECIMENS KIT

SET OF 3 SPECIMENS

- 90° "T" Connection - 0.75" (T) X 20" (Weld Length) X 4" X 8" Leg
- 45° Connection - 0.75" (T) X 20" (Weld Length) X 4" X +8" Leg
- 60° Connection - 0.75" (T) X 20" (Weld Length) X 4" X +8" Leg

SPECIMEN DETAILS

- Each specimen contains 4 flaws / 12 total
- APL Level "C" Criteria used for flaw design
- Flaw accept / reject based on API RP-2X, fig. 45 & 48
- UT specimens can be used for technician practice for offshore structures
- Flaw acceptability is not determined by ultrasonics

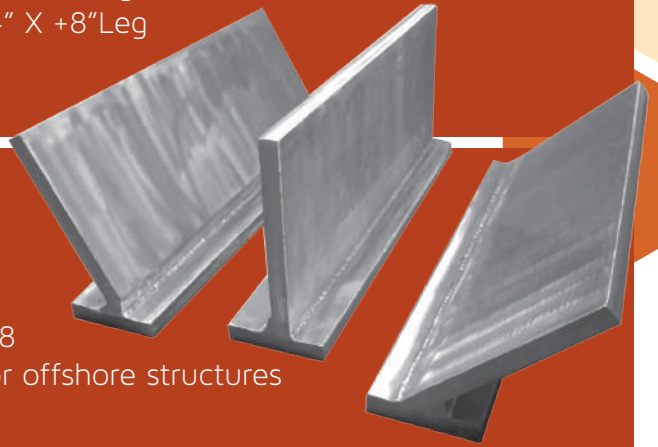

CUSTOM OPTIONS AVAILABLE

#RP2X-PE API RP-2X PRACTICE TEST KIT

Designed in the spirit of API RP-2X, these specimens offer a technician advanced training in UT flaw detection & sizing in unique configurations. This kit is a great tool for conducting practical examinations, as well as preparing technicians for typical industry exams.

THE AP RP-2X EXAM KIT CONTAINS:

- 0.75" T Tee Specimen w/ Double Vee Weld
- 0.75" T 60° "Y" Specimen
- 1 "T Plate Specimen w/ Backing Bar
- 8" Sch40 Pipe Specimen, 180° Segment
- 10-12 Flaws Total, Including Cracks & Weld Discontinuities

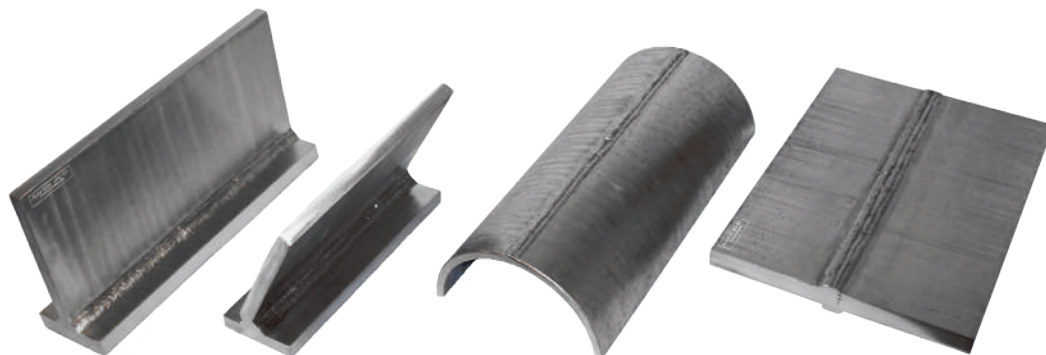

AWS / CWI VISUAL SPECIMEN KIT

Design Specifications Based On AWS D1.1

AWS-K1

KIT CONTAINS 10 SPECIMENS

- Flaws Are Randomly Placed
- (4) Tees 4" X 6" X 2" X 0.25"
- (4) Plates 4" X 6" X 0.25"
- (2) Edge & Lap Joints 4" X 6" X 0.3125"

AWS / CWI KIT DESIGN FEATURES

- 2 Flaws Per Specimen
- Flaws Are Randomly Placed
- Flaws Are "Border Line" Acceptable or Rejectable
- Carbon Steel Specimens
- Welding Process - Smaw
- Document Package W/ Cad Drawings
- "Free" Carrying Case
- Designed Specifically For Visual Weld Inspection Training

AWS / CWI KIT FLAWS

- Undercut
- Crater Crack
- Excessive Convexity
- Undersize Leg
- Cluster Porosity
- Arc Strike
- Overlap
- Longitudinal Crack
- Aligned Porosity
- Incomplete Penetration
- Excessive Reinforcement
- Underfill
- Concavity
- Transverse Crack
- Oversize Leg



TRAVELER CWI VISUAL TRAINING KIT (NEW!)

Design Specifications Based On AWS D1.1

#PCWI-K1

FlawTech's new polymer specimen set developed specifically for CWI training and testing. Efficiently designed to provide a maximum number of indications with minimal weight to support the traveling CWI instructor.

Flaws are Intended to be "Borderline" acceptable or rejectable. The end user (CWI) must make that determination.

KIT SPECIFICATIONS:

- 1 Carrying Case 6" X 16" X 20," ~16lbs
- All 15 samples fit into one case
- Light weight for easy transport
- Complete document package includes CAD drawings
- 3 to 4 flaws per specimen for a total of 50 weld flaws per kit
- Specimens also contain various weld bevels and flame cut edges
- (6) Plates
- (3) Tee Joints
- (6) 180° Pipe Segments

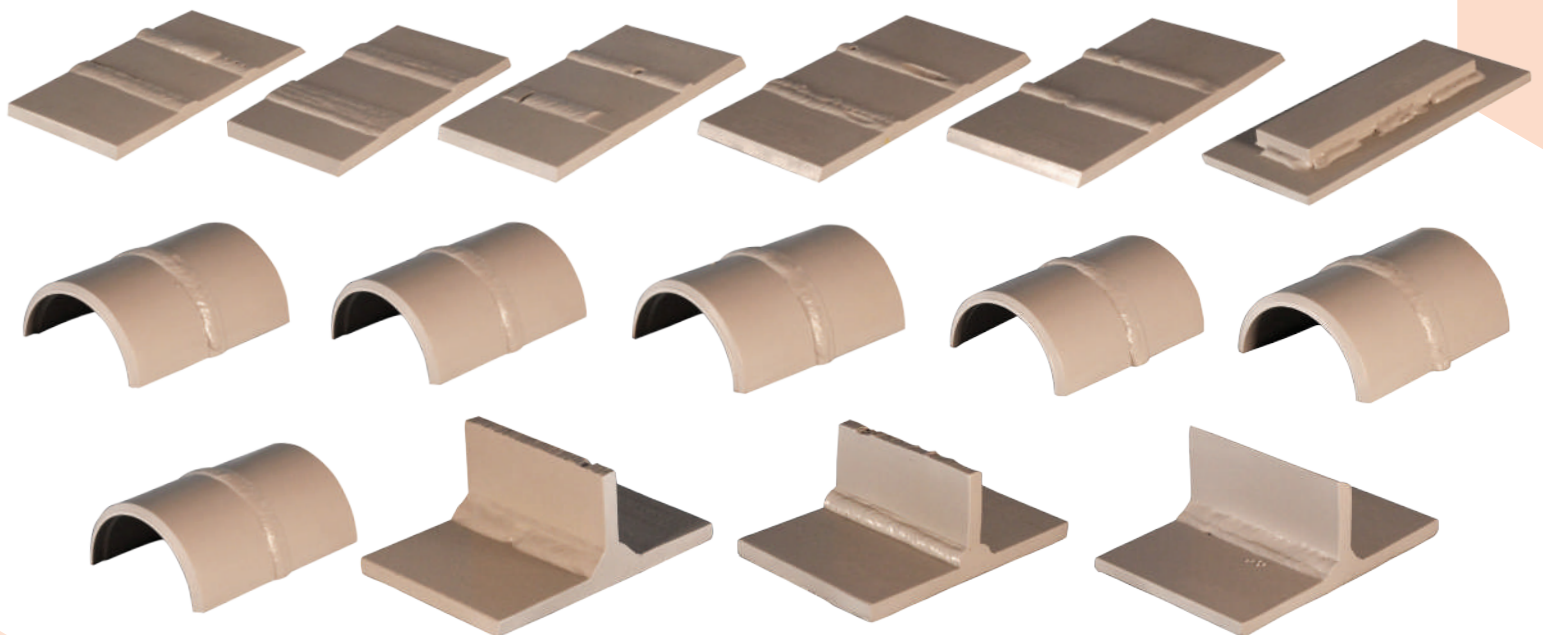

(Optional) Weld Size and CAM Gauges



AWS / CWI PLUS PT ENDORSEMENT KIT

#AWS-K2

Design Specifications Based On AWS

Kit Contains 10 Specimens

- (2) PLATES 4" X 6" X 0.25"
- (1) PIPE 4" SCH80 X 6"
- (1) TEE 4" X 6" X 2" X 0.25"
- (1) SOCKET WELD 2" SCH80 X 6"
- (5) PLATES 1" X 4" X 0.25"

AWS / CWI KIT DESIGN FEATURES:

- 2 + Flaws Per Specimen
- Flaws Are Randomly Placed
- Flaws Are "Border Line" Acceptable Or Rejectable
- Carbon Steel Specimens
- Welding Process - SMAW
- Document Package W/ CAD Drawings
- "Free" Carrying Case
- Designed Specifically For Visual Weld Inspection Training

AWS/CWI CERTIFIED KIT

- FlawTech worked in conjunction with AWS and EPRI in the development of this kit.
- This kit has been designed to incorporate both basic penetrant training and testing of the CWI



AWS STRUCTURAL WELD SEISMIC KIT

#AWS-SSK

Based On AWS D1.8 Annex E For Structural Welds

AWS Seismic Supplement for UT Testing

AWS SEISMIC KIT CONTAINS:

TOTAL OF 8 CARBON STEEL SPECIMENS

- (2) Butt Welds W/ V Groove (1) At 0.375" T & (1) At 0.75" T X 6" (Weld) X 8"
- (2) Butt Welds W/ V Groove & Backing Bar (1) At 0.375" T & (1) At 0.75" T X 6" (Weld) X 8"
- (2) Tee Welds W/ Single Groove, (1) At 0.375" T & (1) At 0.75" T X 6" (Weld) X 4" (Main) X 7" (Branch)
- (2) Tee Welds W/ Single Groove W/ Backing Bar, (1) @0.375" T & (1) @ 0.75" T X 6" (Weld) X 4" (Main) X 7" (Branch)

KIT STANDARD FEATURES

- Complete Document Package W/ CAD Drawings ~2-3 "Real" Flaws per Specimen
- Flawtech Advanced Tolerance +/- 0.080"
- As Welded Crowns And Roots
- Carrying Case 24" X 16" X 10", ~110Lbs



A **FLAWTECH** Original Kit

FLAW MANUFACTURING TECHNOLOGY

24

SOCKET WELD SPECIMEN KIT

Pipe to Fitting & Pipe to Vessel Specimens

SET OF 6 SOCKET WELD SPECIMENS

3 ALLOY OPTIONS

- 304 S/S #SOC - K1
- 316 S/S #SOC - K2
- 106 C/S #SOC - K3

PIPE DIMENSIONS

- 0.75" SCH80
- 1.0" SCH 80
- 2.0" SCH 80

FLAW SPECIFICATIONS

- 2 Flaws Each Specimen
- Total Of 12 Real Flaws
- Fatigue, Haz Cracks, and Lacks of Fusion

2 SPECIMENS PER PIPE SIZE

- (1) Pipe To Socket Coupling
- (1) Pipe To 1.5" X 6" X 6" Plate w/ Machined Socket

PURCHASE OPTIONS

- Kit / Set Contains 6 Specimens
- Individually / Purchase 1 Or More
- Customize Your Set / Mix Different Alloys

Specimens are Designed for Ultrasonic Practice Inspection of Pipe To Fitting and Pipe to Vessel Welds

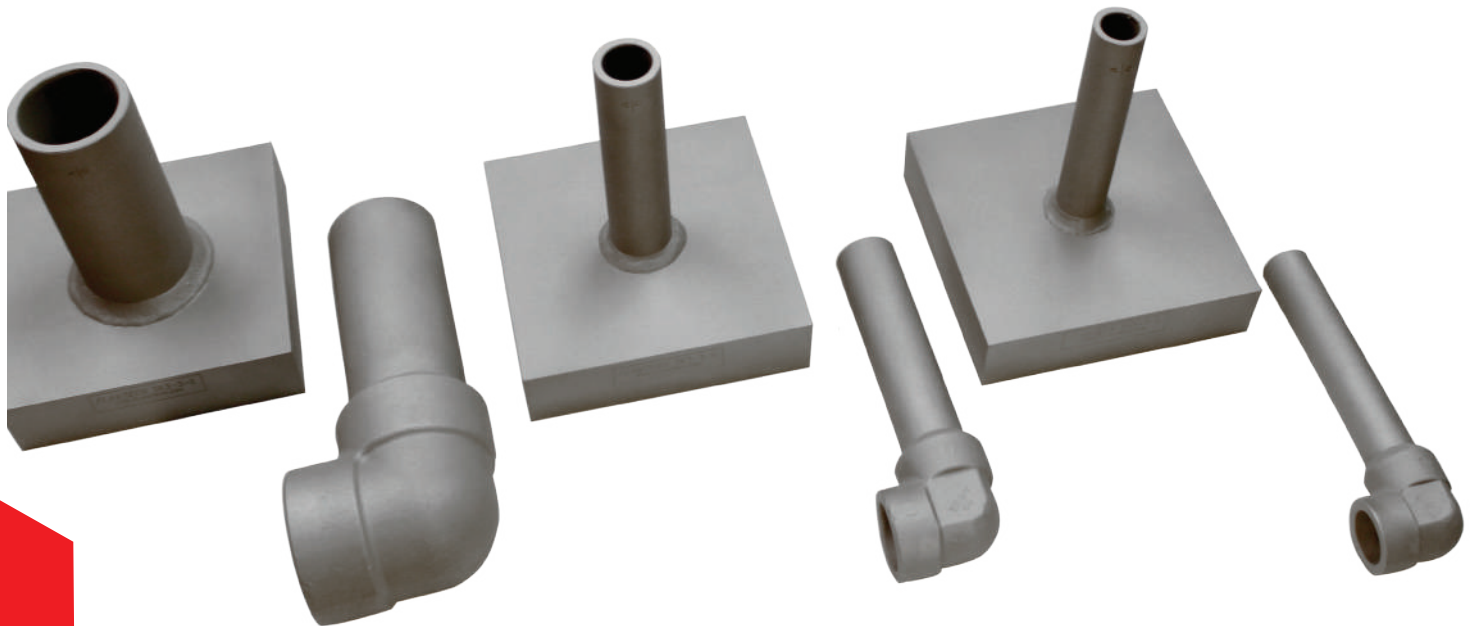

#EPRI-K1

BOILER TUBE DAMAGE KIT

Designed and Manufactured to Replicate Field Removed Specimens

KIT CONTAINS

19 BOILER TUBES:

- Representing a complete range of fossil-fired boiler tube failure mechanisms steam and water touched.

TUBE SPECIFICATIONS:

- 18 Tubes At 2.5" OD X 0.25" Wall X 8" Long
- 1 Tube At 1.5" X 0.25" Wall X 8" Long

MATERIAL

- 17 Tubes are SA513 T5 GR 1020/1026 C/S
- 1 Tube is 304/304L
- 1 Dissimilar metal weld

FLAWS / INDICATIONS

- Long term overeating/creep
- Fire side corrosion (coal)
- Toe crack, stress corrosion (stainless)
- Soot blower erosion
- Fatigue crack (toe)
- Maintenance damage
- Pitting
- Rubbing / Fretting
- Chemical cleaning damage (cleaning & pitting)
- Material flaw (forging lap)
- Corrosion fatigue crack
- Fly ash erosion, Hydrogen damage
- Acid Phosphate erosion
- Caustic gouging
- Supercritical waterwall cracking (1.5" OD tube)
- Weld defects (lack of fusion and porosity)
- Graphitization

EPRI Program 63 Members Receive a Special Discount.

Use This Kit To Assist In The Training And Qualifying Of NDE Technicians To Accurately Identify Specific Boiler Tube Damage Found In Fossil Plants.



OFFICIALLY LICENSED BY

EPRI

ELECTRIC POWER
RESEARCH INSTITUTE

A **FLAWTECH** Original Kit

FLAW MANUFACTURING TECHNOLOGY

26

#A7-K1 ASME SECTION XI APPENDIX VII KIT

8 piece specimen set

Contains 20 "real flaws"

For training and Qualification

2 - WELDED PLATES

- (1) CARBON STEEL PLATE: #A7-CS-005
- (1) STAINLESS PLATE: #A7-SS-005
- 0.5" X 10" X 12"

2 - WELDED PLATES

- (1) CARBON STEEL PLATE: #A7-CS-010
- (1) STAINLESS PLATE: #A7-SS-010
- 1.0" X 10" X 12"

1 - WELDED PIPE

- (1) STAINLESS PIPE: #A7-SS-020
- 2" SCH160 X 12"

1 - WELDED PIPE

- (1) CARBON STEEL PIPE: #A7-CS-040
- 4" SCH160 X 12"

1 - WELDED PIPE

- (1) STAINLESS PIPE: #A7-SS-060
- 6" SCH160 X 12"

1 - WELDED PIPE

- (1) CARBON STEEL PIPE: #A7-CS-100
- (180° SEGMENT)
- 10" SCH160 X 12"



KIT SPECIFICATIONS

- Each specimen contains two to four "real flaws" designed to meet appendix VII specifications.
- Specimens are manufactured to FlawTech's advanced tolerance of +/- 0.080".
- No two specimens are alike. Buy two sets, one for testing and one for training.
- Document package includes CAD drawings, certificates of conformance, and NDT reports.
- Custom options available such as 10% notches, blank specimens, and the purchase of individual flawed specimens. Contact FlawTech for more details.

ASME SECTION XI APPENDIX VIII KITS

ASME BOILER & PRESSURE VESSEL CODE, SECTION XI, APPENDIX VII, SUPPLEMENTS 2, 3 & 10 KITS

#S2-K1

SUPPLEMENT 2 KIT FOR
AUSTENITIC PIPING
360 lbs

PIPE SPECIMEN DIMENSIONS	UNFLAWED UNITS	FLAWED UNITS
2" SCH80 X 24" 360°	1	1
4" SCH80 X 24" 360°	3	1
6" SCH160 X 24" 360°	4	2
12" SCH80s X 24" 360°	9	3
24" SCH80s X 24" 120°	5	3
KIT TOTAL - 5 SPECIMENS	22	10

#S3-K1

SUPPLEMENT 3 KIT FOR
FERRITIC PIPING
350 lbs

PIPE SPECIMEN DIMENSIONS	UNFLAWED UNITS	FLAWED UNITS
2" SCH80 X 24" 360°	1	1
4" SCH80 X 24" 360°	3	1
6" SCH160 X 24" 360°	4	2
12" SCH80s X 24" 360°	9	3
24" SCH80s X 24" 120°	5	3
KIT TOTAL - 5 SPECIMENS	22	10

#S10-K1

SUPPLEMENT 10 KIT FOR
DISSIMILAR METAL WELDS
340 lbs

PIPE SPECIMEN DIMENSIONS	UNFLAWED UNITS	FLAWED UNITS
4" SCH80 X 24" 360°	1	2
6" SCH160 X 24" 360°	3	2
8" SCH80 X 24" 360°	4	3
12" SCH80s X 24" 180°	9	4
24" SCH80s X 24" 90°	5	4
KIT TOTAL - 5 SPECIMENS	22	15

KIT AND FLAW DETAILS:

- The kits are manufactured to meet the minimum requirements of ASME, boiler & pressure code, Section XI, Appendix VIII, of Supplements 2, 3 & 10
- At least 50% of the cracks will be coincident with fabricated conditions such as: ground & AS-welded crowns, counterbores & weld root conditions.
- Flaw depths will range from the 10-30% through the 61 - 100% depth ranges as in ASME section XI, appendix VIII.
- All the flaws will be mechanical fatigue or thermal fatigue cracks, with at least 75% of the cracks being thermal fatigue.
- Kits made to our critical tolerance $\pm 0.040"$ (1MM).
- Custom appendix VIII specimens are available.
- Contact FlawTech for more details.



UT CALIBRATION BLOCKS

ASTW AWS Navships FBH Sensitivity IIW Stepwedges

Angle Beam Phased Array Distance Amplitude Resolution Block

Metric Or Standard Custom

Type 1 #IIW-TI-1
Metric: #IIW-T1-1M



Type 2 #IIW-T2-1
Metric: #IIW-T2-1M



V1/5 (A2)
#IIW-V1-1



5 Step #5S-CB-1



4 Step #4S-CB-1



Custom Step Blocks

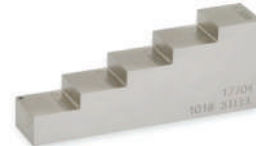

DC Block
#DC-CB-1



Resolution Block (RC)
#RC-CB-1



DSC Block #DSB-CB-1
Metric: #DSB-CB-1M



DS Block #DS-CB-1



Set of 8
#DA-S8-1



Set of 10
#DA-S10-1



Set of 19
#DA-S19-1



Mini Angle Beam Block
#MAB-CB-1

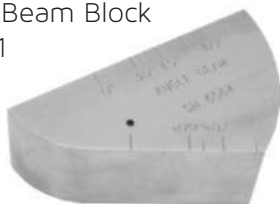

"PACS" Phased Array Test Block
#PACS-1



V2 (A4) Cal Block
#V2-CB-1

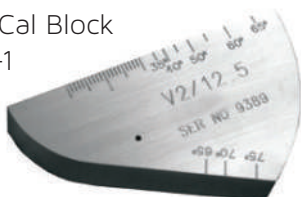

ISO 7963 Test Block #2
#ISO-TB-2

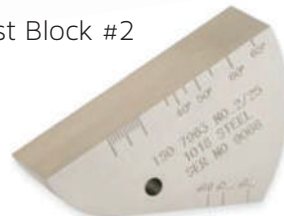

PDI UT CALIBRATION BLOCKS

PDI ALTERNATIVE ASME CALIBRATION BLOCKS

The PDI Alternative ASME blocks meet the requirements of the Performance Demonstration Initiative (PDI) Procedure No. PDI-UT-1, Rev. C, Fig. 4(Ferritic) and PDI-UT-2, Rev. C, Fig.4(Austenitic).

These blocks cover the generic procedures for the ultrasonic examination of both ferritic and austenitic pipe welds.

The blocks offer users an economical alternative to fabricating multiple curved cal blocks (pipe sections) in many diameters and wall thicknesses.

The blocks are normally supplied in sets of 3 individual blocks; A516 Grade 70 Carbon Steel, Type 304/304L Stainless Steel, and also in Type 316/316L Stainless Steel. Individual blocks of any one alloy may also be purchased. The blocks are made from ultrasonically inspected, heat number- traceable material.

The block design consists of four (4) steps (representing wall thicknesses) measuring 0.5", 1.0", 1.5", and 2.0". Each step contains an EDM notch machined to a depth of 10% of wall x .010" wide x 2.0" long. Overall block size is 2.00" wide x 2.25" tall x 10.00" long.

The scanning and reflecting surfaces are intentionally machined to simulate pipe and plate surfaces of 250 Ra maximum finish. Each block is permanently machine-engraved on one edge to include the block description, serial number, alloy, and heat number.

Contact FlawTech for all your Standard and Custom Calibration Block Needs.
All materials available upon request.

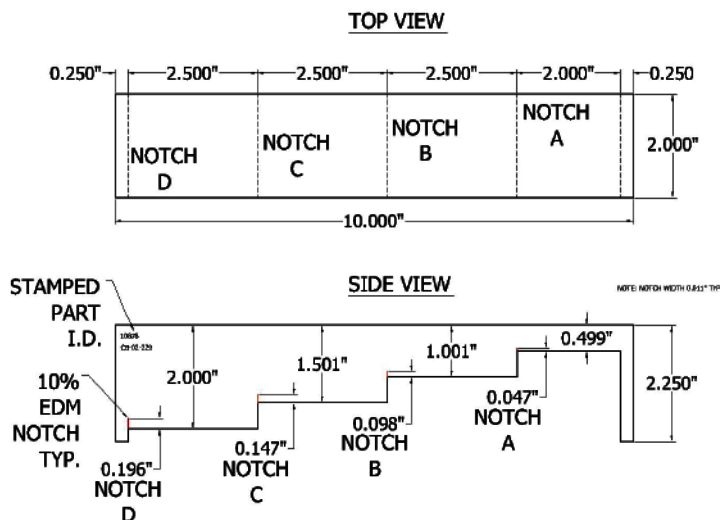
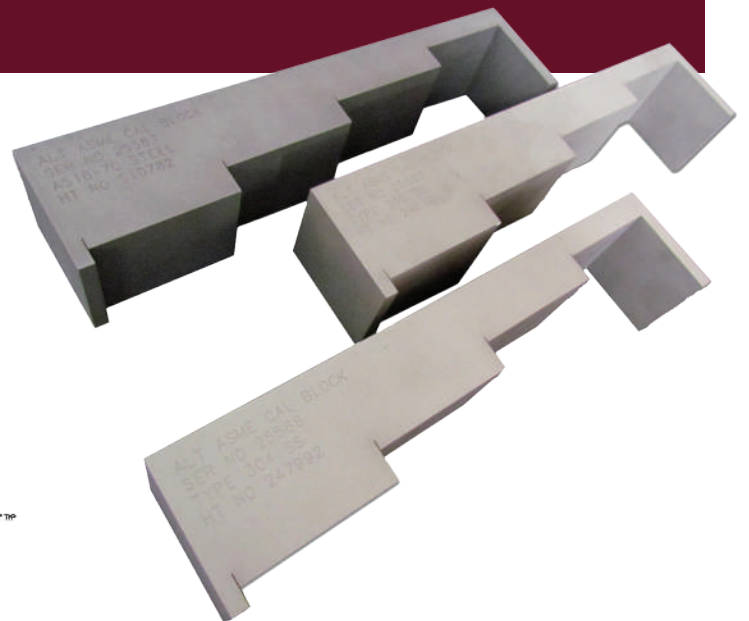

ASME UT CALIBRATION STANDARDS

ASME SEC. V BASIC CALIBRATION BLOCKS

The block is used for establishment of primary reference responses for UT examination welds. Block contains three (3) DAC side drilled holes at 1.5" deep minimum at diameters between 0.0937" and 0.25" depending on the block thickness (T). Hole locations through the thickness are 1/4, 1/2, and 3/4 T. The block will also two (2) notches measuring 2% (T) deep x 1.0" long minimum. Specification: ASME Section V, Article 4, Figure T-434.2.1. Dimensions: T x 6.25" x 3 (T) minimum. Block is available in normal thicknesses of 0.5", 1.5", 3" and 5".



ASME SEC. V ANGLE BEAM CALIBRATION BLOCKS

The basic calibration block for weldments shall be a section of pipe of the same normal size, schedule, heat treatment and material specification as the material being examined. Standard will contain four (4) notches, two (2) longitudinal and two (2) circumferential on both the OD and ID at a target depth of 9.5% of nominal wall thickness and a minimum of 1" long. FlawTech can provide the material or use customer furnished material. In accordance with ASME Sec V, Article 4, Figure T-434.3 (Calibration Block for Pipe.)

Those listed are just a few of the many ASME calibration standards available. Contact FlawTech for more information.

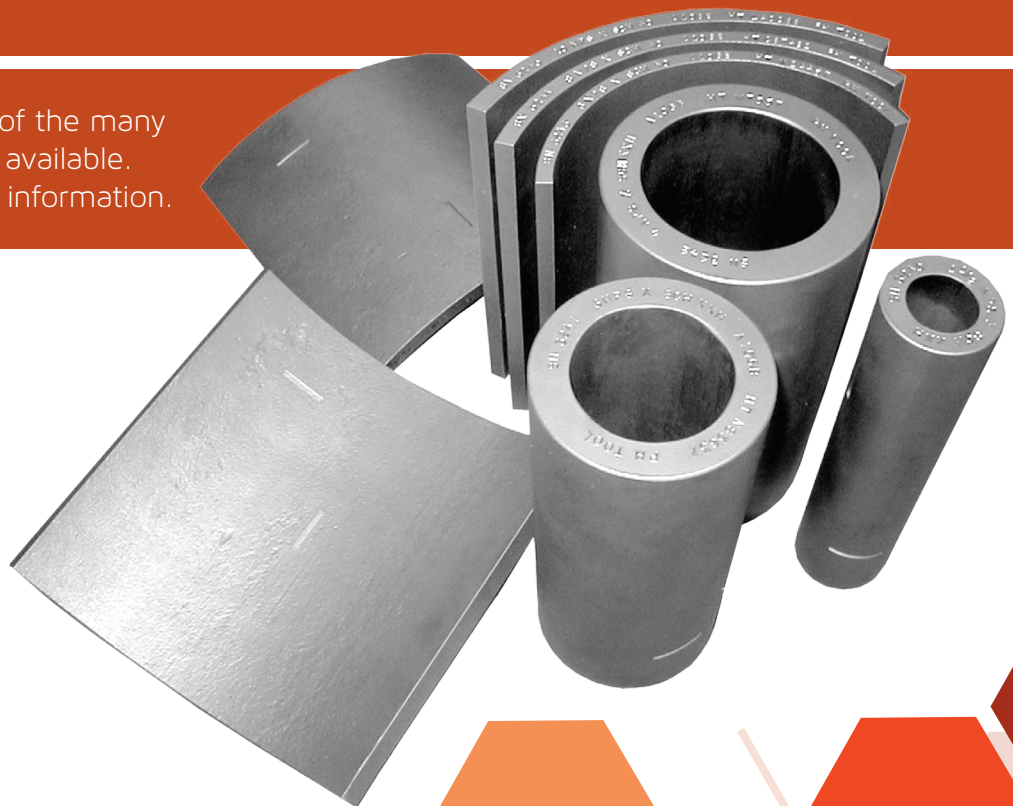

PDI UT 10 CALIBRATION STANDARDS

PDI CONTOURED CALIBRATION BLOCKS FOR DISSIMILAR METAL (DM) WELDS

Contoured calibration blocks are used in the manual examination of dissimilar metal (DM) welds and base materials including piping susceptible to Stress Corrosion Cracking (SCC). The blocks are used to establish a reference sensitivity level from which subsequent exams may be compared. The blocks are precisely machined to fit contoured search units for axial and circumferential scanning directions. Customer specifies block contour radius based on diameter of material being inspected. Blocks are manufactured in Type 304 or Type 316 Stainless Steel and are certified to meet Performance Demonstration Initiative PDI-UT-10 and PDI-UT-8.

Contact FlawTech for all your Standard and Custom Calibration Block Needs.

All materials available upon request.



NOTES

Contact *FlawTech* www.FlawTech.com TEL: 704.795.4401 FAX: 704.795.4403





To Order the Highest Quality Flawed Specimens:

www.FlawTech.com

Tel: 704.795.4401

Fax: 704.795.4403